

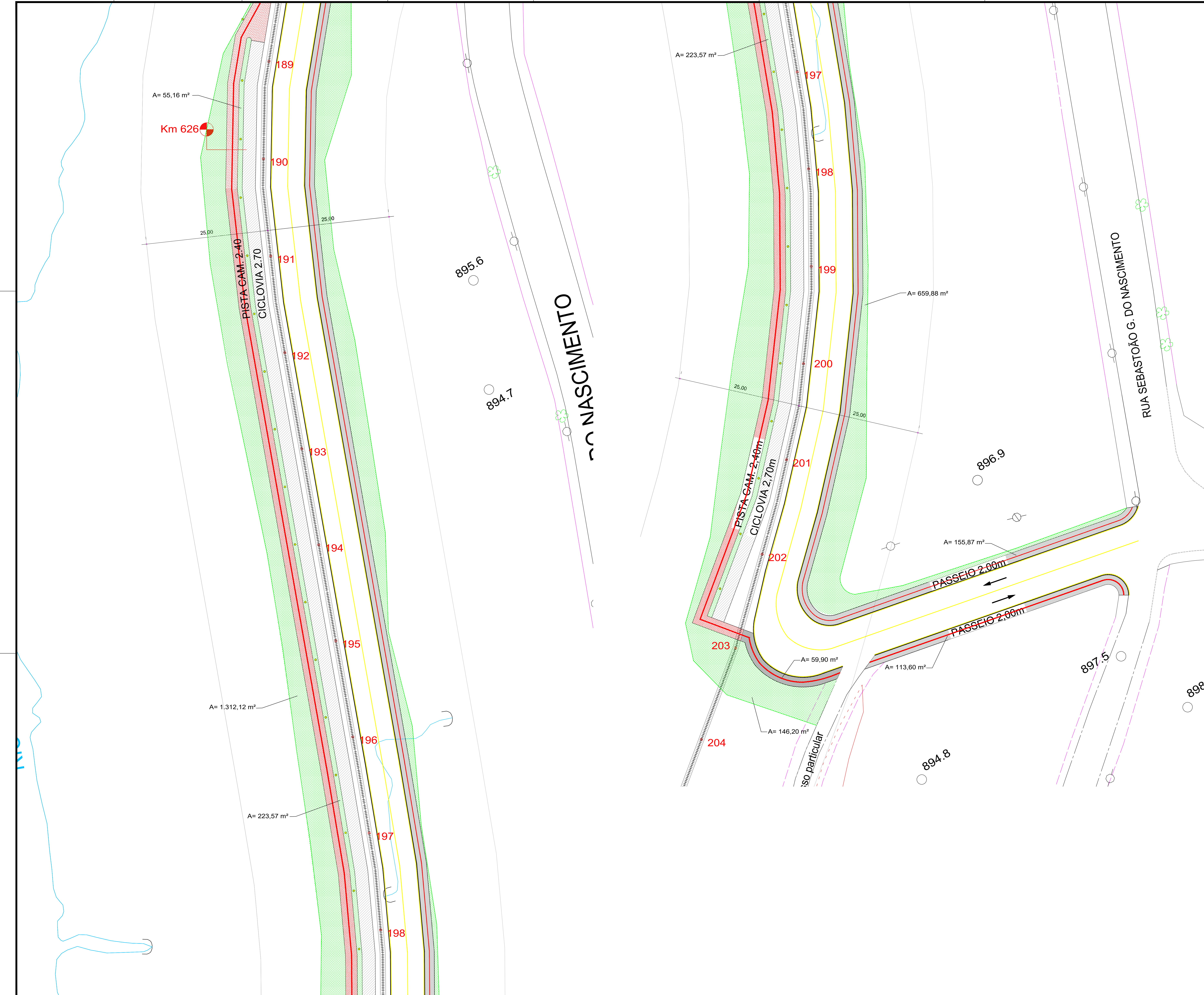



GEOMÉTRICO - PARQUE LINEAR DE CAÇADOR	
	Referência PARQUE LINEAR DE CAÇADOR LEVANTAMENTO DE SERVIÇOS TRECHO ESTACA 177 - 203 TRECHO 05
Responsável Técnico EMERSON SCHMIDT - CREA 45145-0	Área INDICADA Escala 1/250 Desenho EMERSON Arquivo D:\Instituto\PARQUE LINEAR PARCELO 05.dwg
	FOLHA 01/09 Data 12 março 2020



GEOMÉTRICO - PARQUE LINEAR DE CAÇADOR	
 <p>IPPUC INSTITUTO DE PESQUISA E PLANEJAMENTO URBANO DE CAÇADOR</p>	<p>Referência PARQUE LINEAR DE CAÇADOR LEVANTAMENTO DE SERVIÇOS TRECHO ESTACA 177 - 203 TRECHO 05</p>
	<p>FOLHA 02/09</p>
<p>Responsável Técnico EMERSON SCHMIDT - CREA 45145-0</p>	<p>Data 12 março 2020</p>
<p>Área INDICADA</p>	
<p>Escala 1/250</p>	
<p>Desenho EMERSON</p>	
<p>Arquivo D:\Instituto\PARQUE LINEAR\TRECHO 05.dwg</p>	

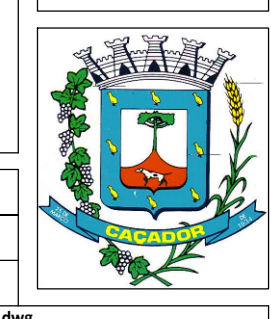
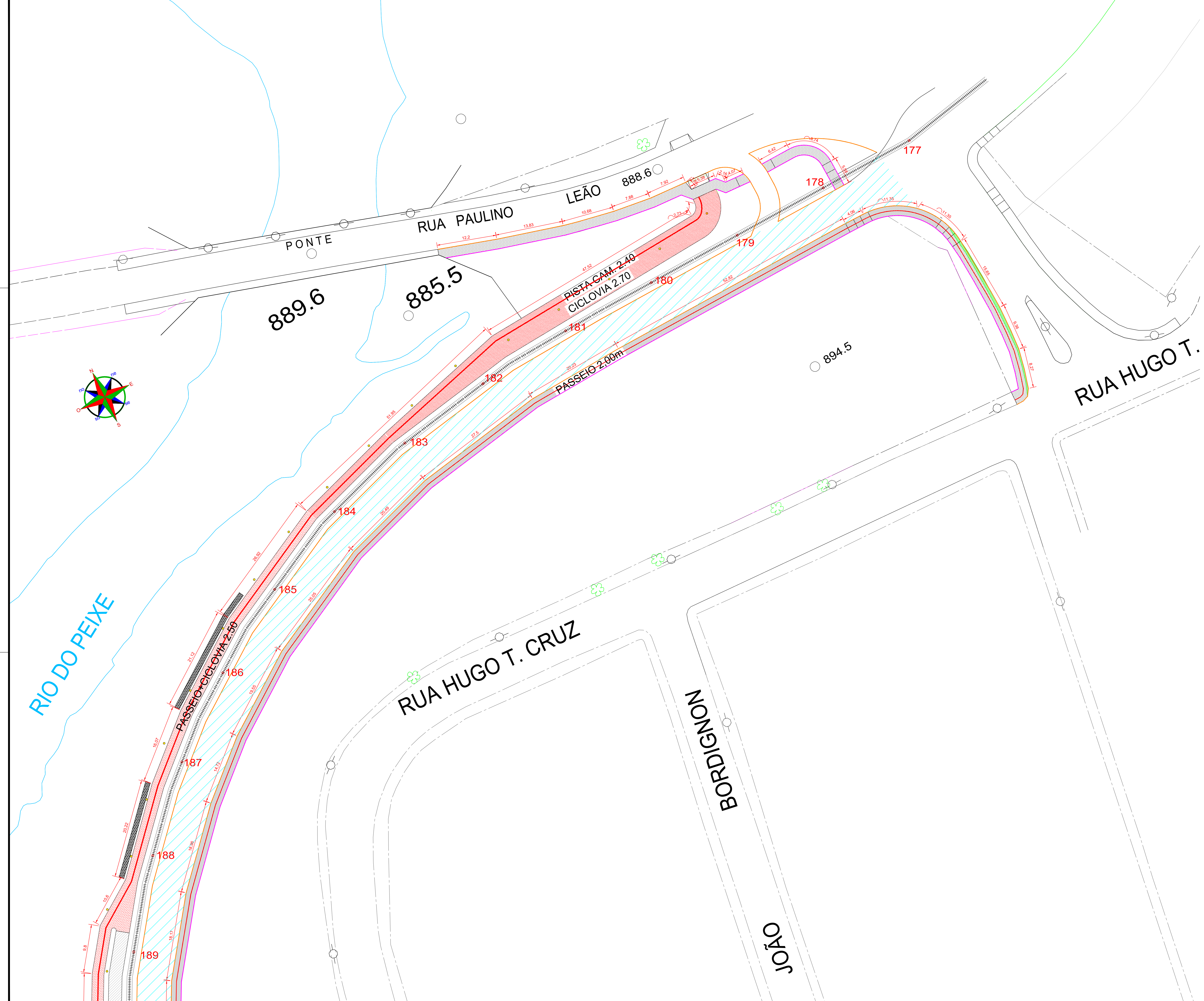

GEOMÉTRICO - PARQUE LINEAR DE CAÇADOR	
 <p>IPPUC INSTITUTO DE PESQUISA E PLANEJAMENTO URBANO DE CAÇADOR</p>	<p>Referência</p> <p>PARQUE LINEAR DE CAÇADOR LEVANTAMENTO DE SERVIÇOS - COTAS TRECHO ESTACA 177 - 203 TRECHO 05</p>
	<p>FOLHA</p> <p>03/09</p>
<p>Responsável Técnico</p> <p>EMERSON SCHMIDT - CREA 45145-0</p>	<p>Data</p> <p>12 março 2020</p>
<p>Área INDICADA</p> <p>Escala 1/250</p> <p>Desenho EMERSON</p> <p>Arquivo D:\Instituto\PARQUE LINEAR PARCELO 05.dwg</p>	

Km 626

PISTA-CAM. 2.40
CICLOVIA 2.70

RUA SEBASTÃO G. DO NASCIMENTO

PISTA-CAM. 2.40m
CICLOVIA 2.70m

PASSEIO 2.00m
PASSEIO 2.00m

RUA SEBASTÃO G. DO NASCIMENTO

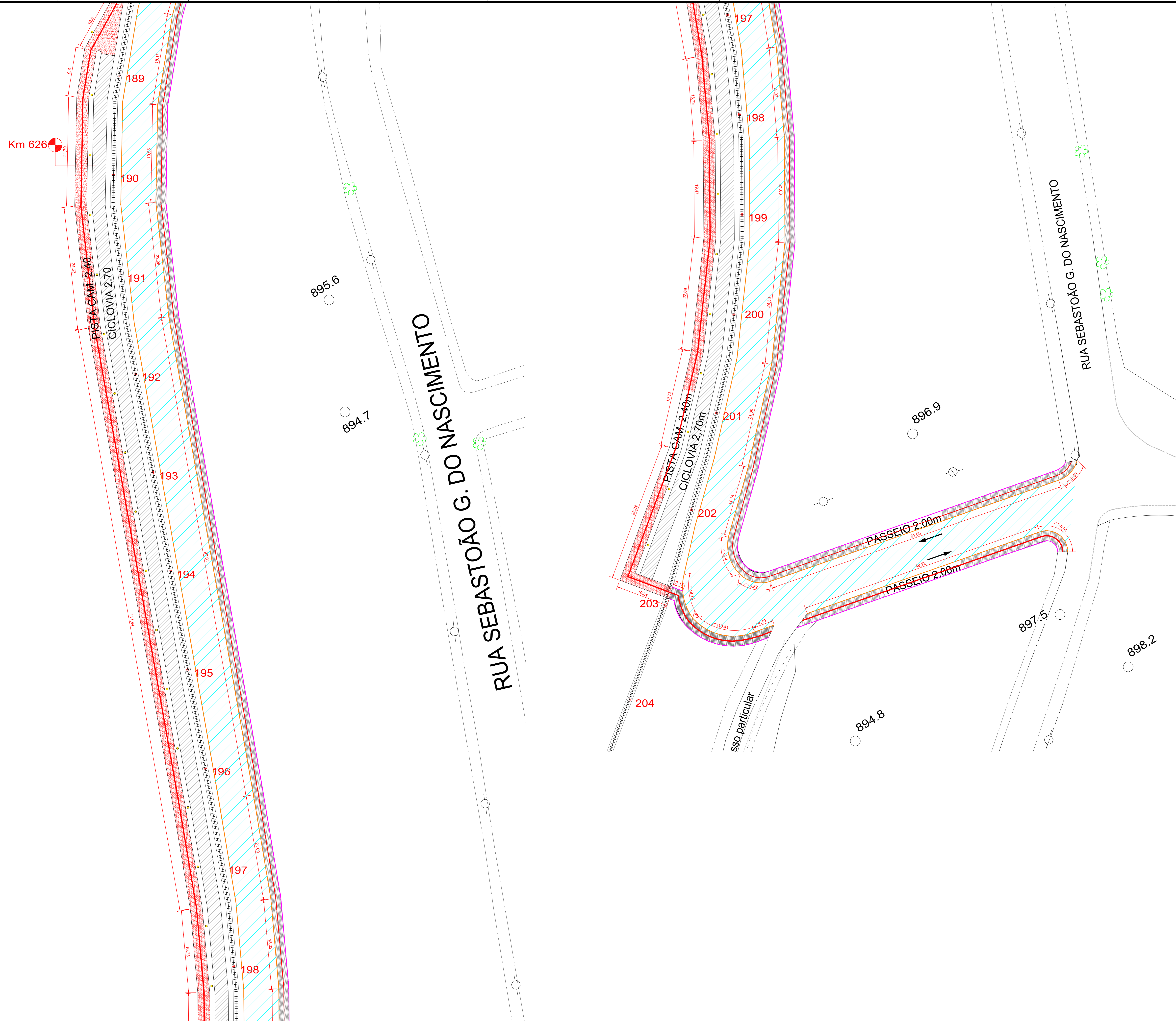

GEOMÉTRICO - PARQUE LINEAR DE CAÇADOR		FOLHA
 <p>IPPUC INSTITUTO DE PESQUISA E PLANEJAMENTO URBANO DE CAÇADOR</p>	Referência PARQUE LINEAR DE CAÇADOR LEVANTAMENTO DE SERVIÇOS - COTAS TRECHO ESTACA 177 - 203 TRECHO 05	04/09
	Responsável Técnico EMERSON SCHMIDT - CREA 45145-0	Área INDICADA Escala 1/250 Desenho EMERSON Arquivo D:\Instituto\PARQUE LINEAR PARCELO 04.dwg

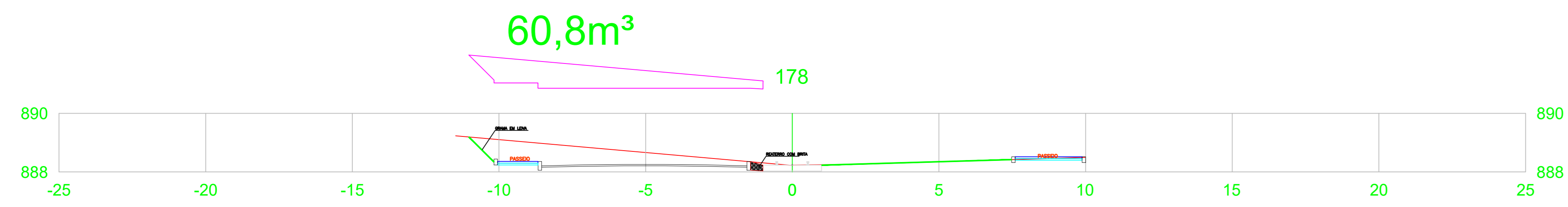

ESTACA 178

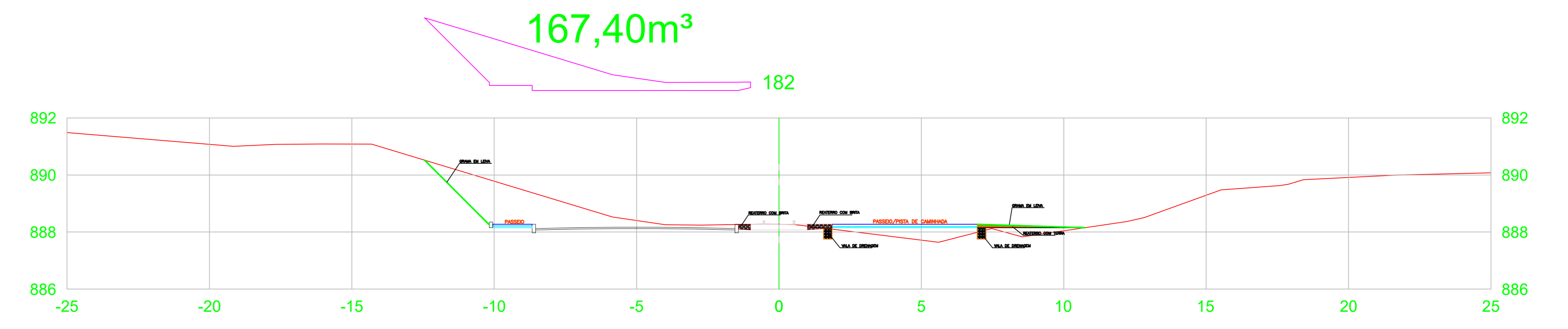

ESTACA 182

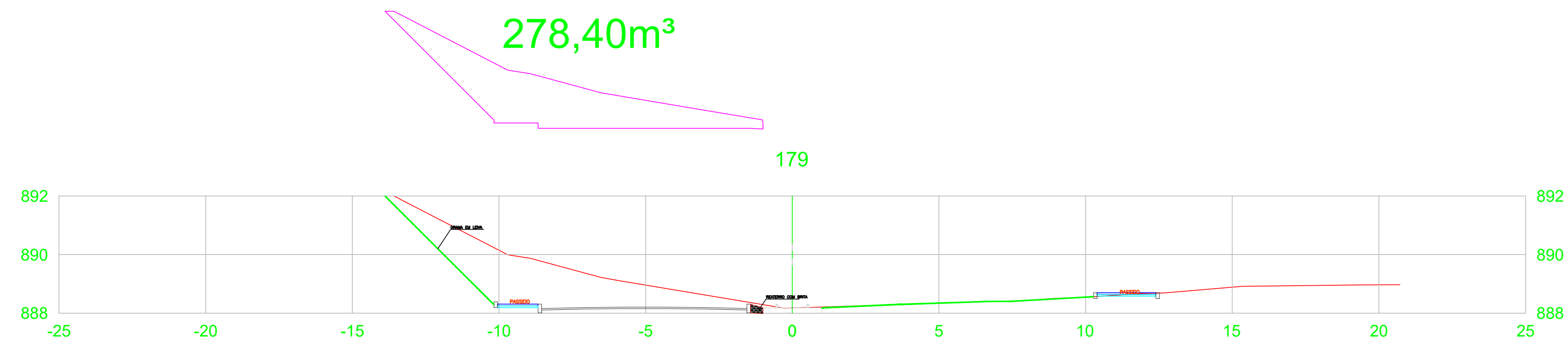

ESTACA 179

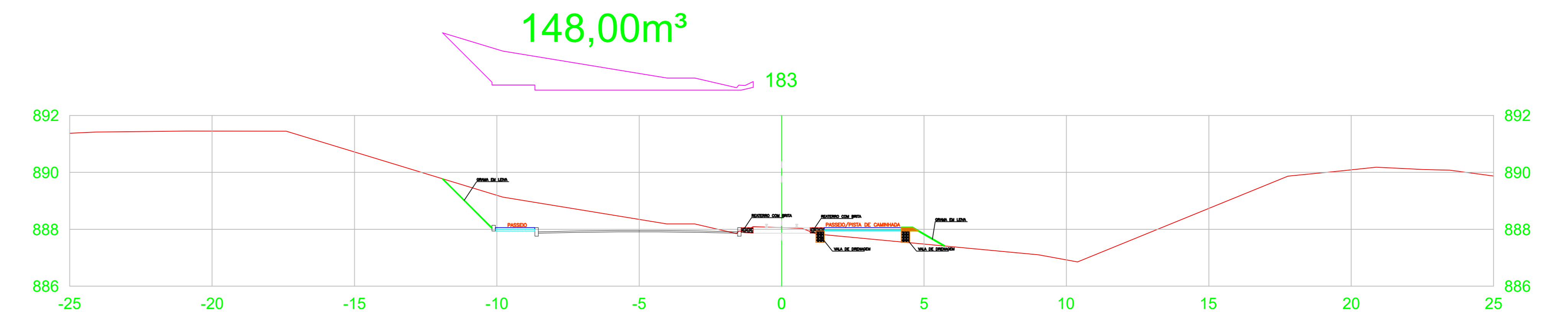

ESTACA 183

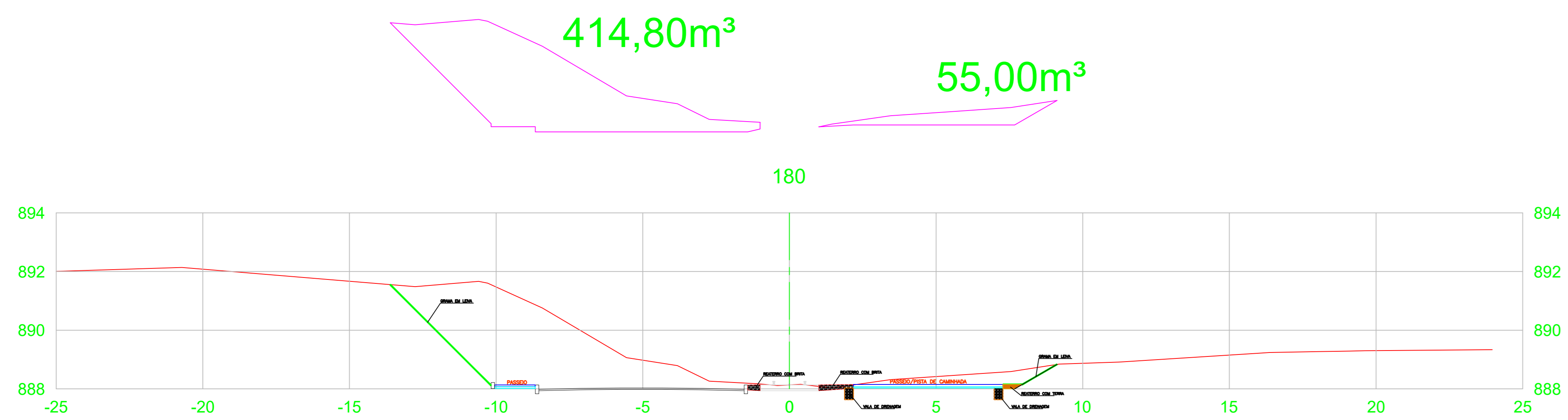

ESTACA 180

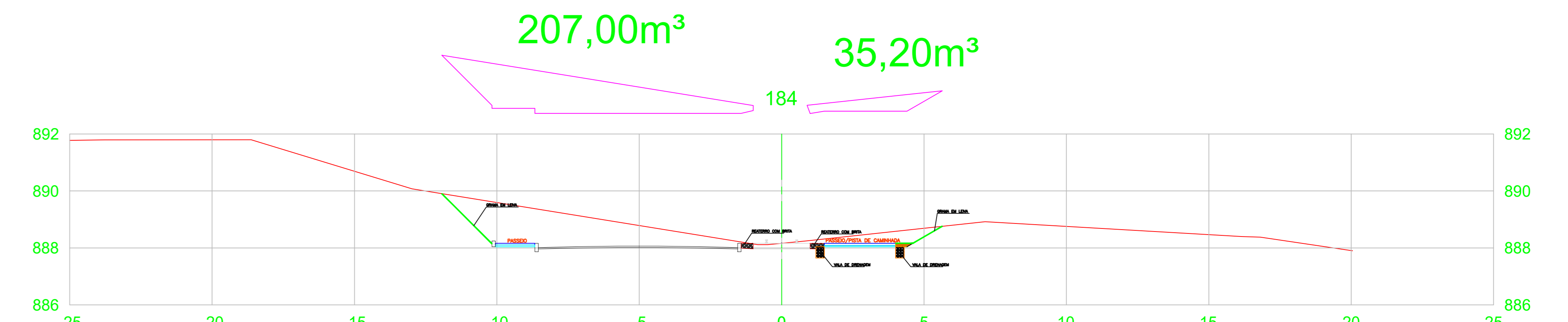

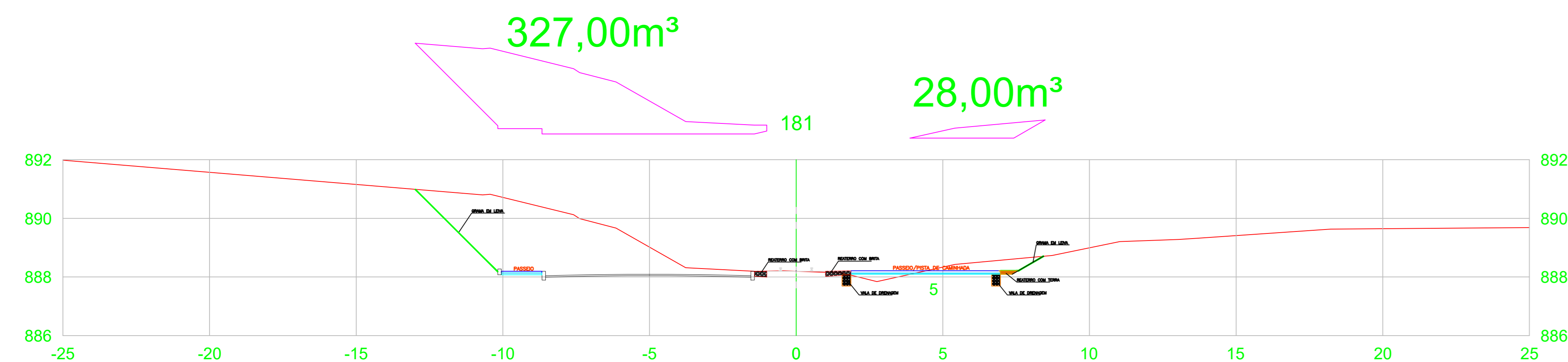

ESTACA 184

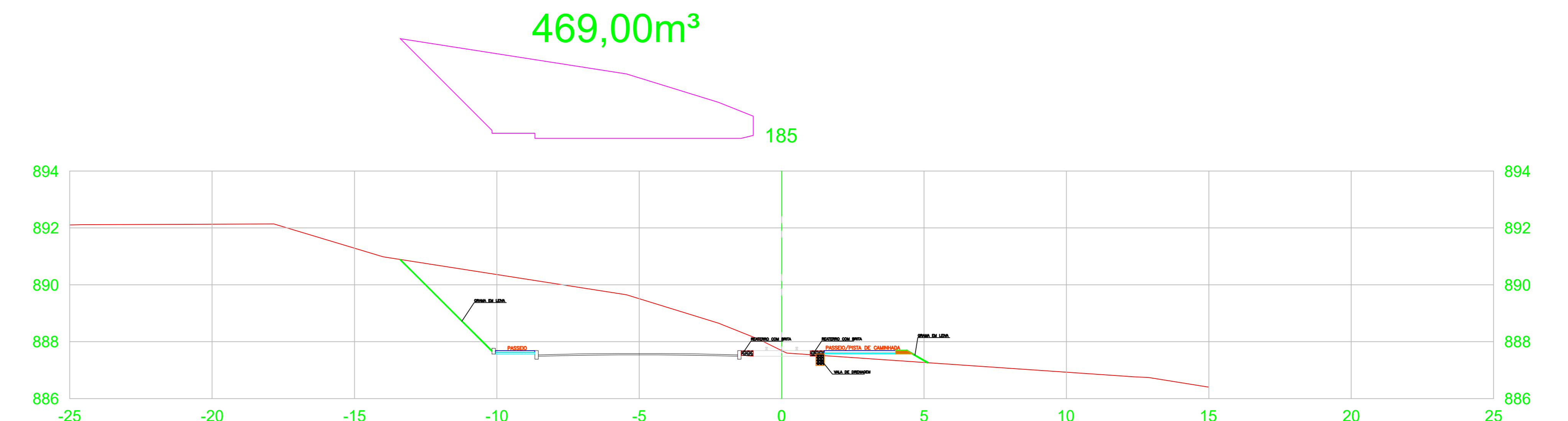

ESTACA 181



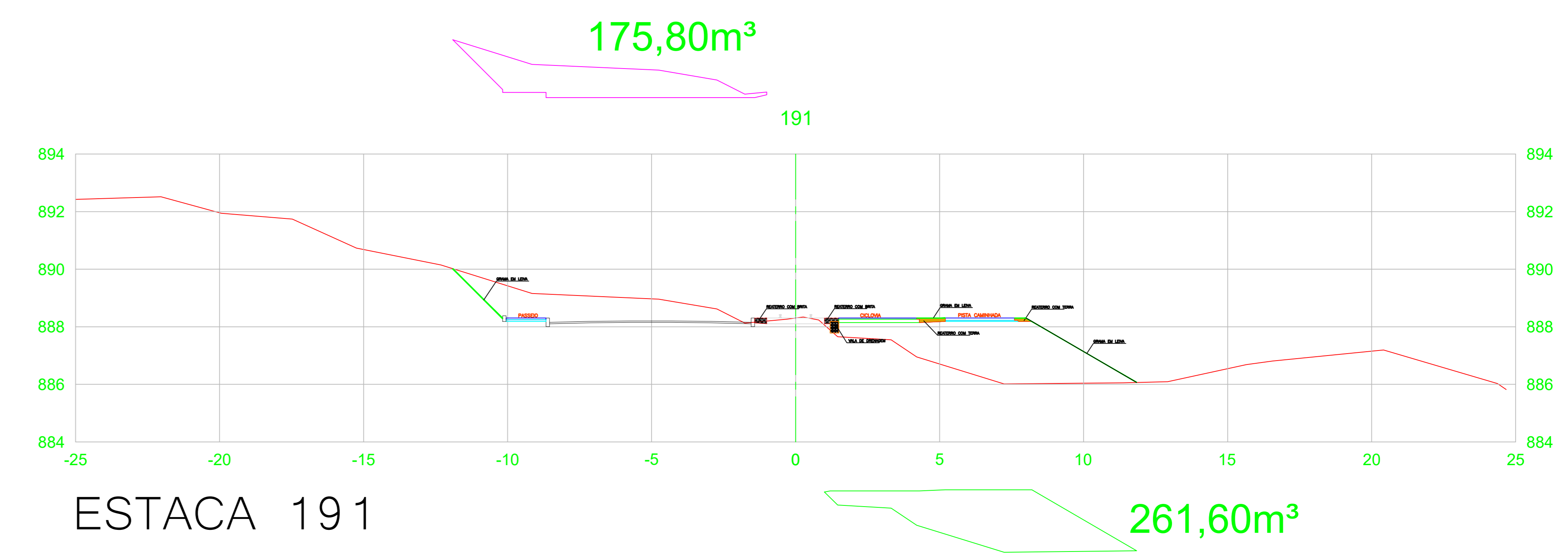
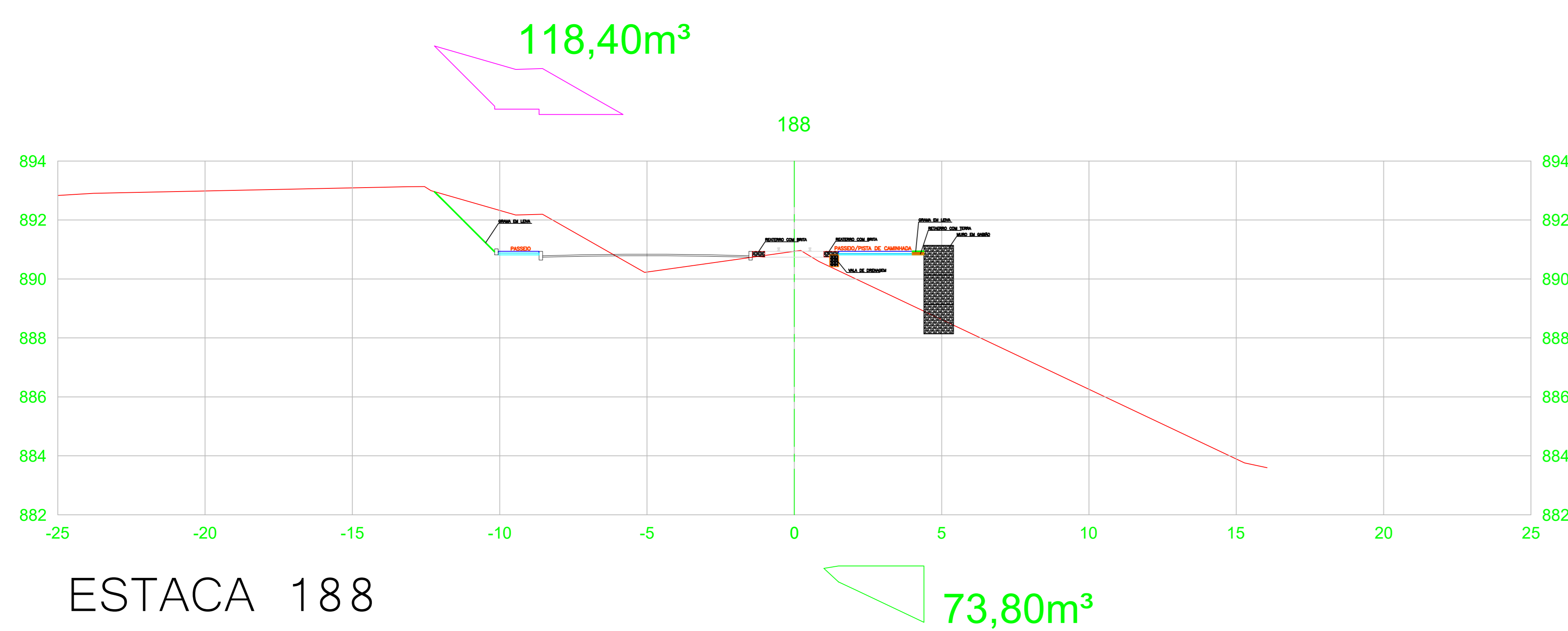
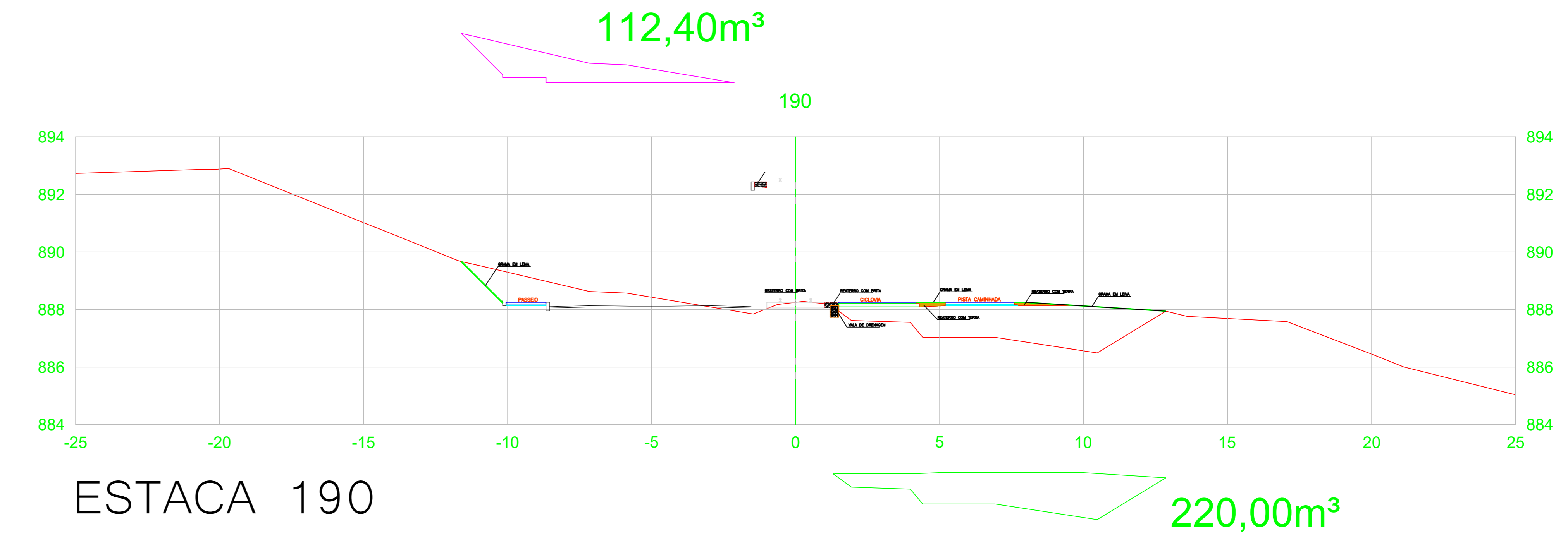
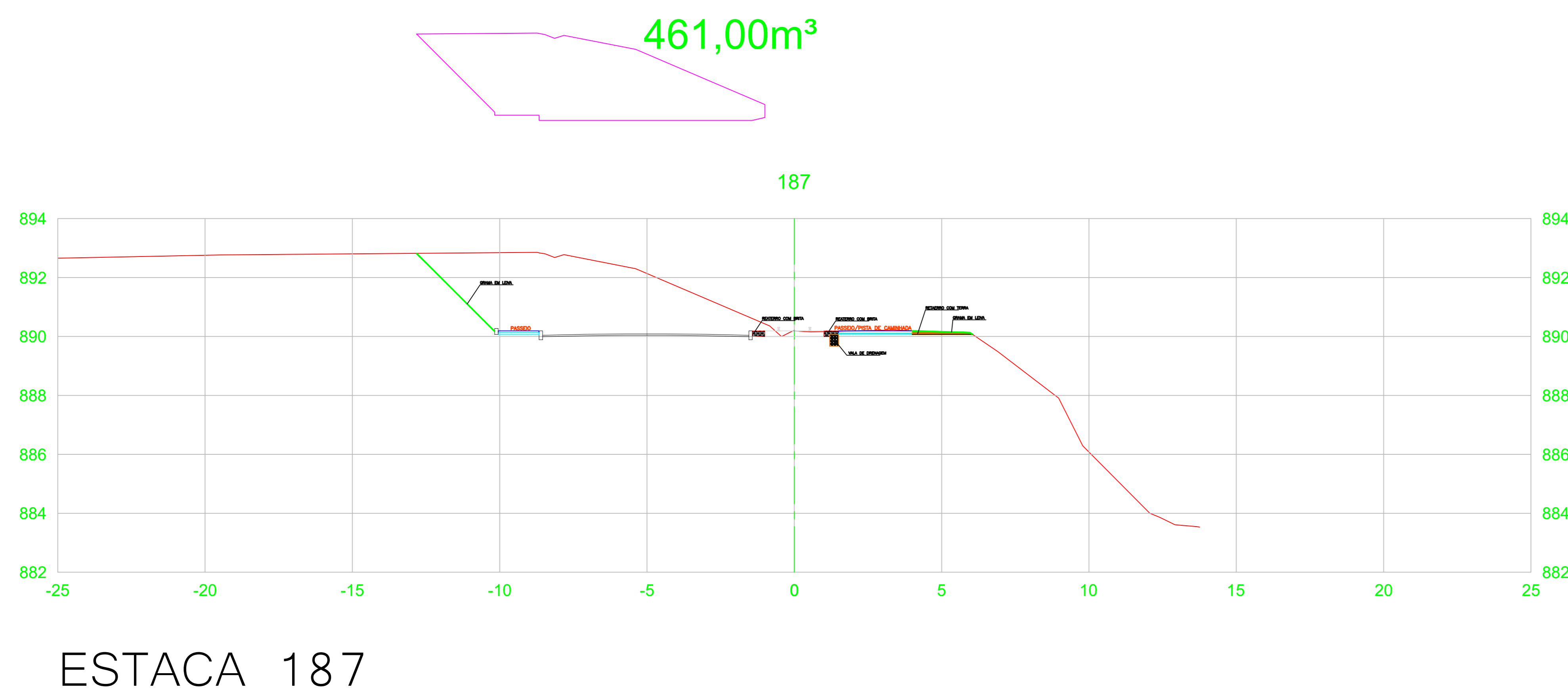
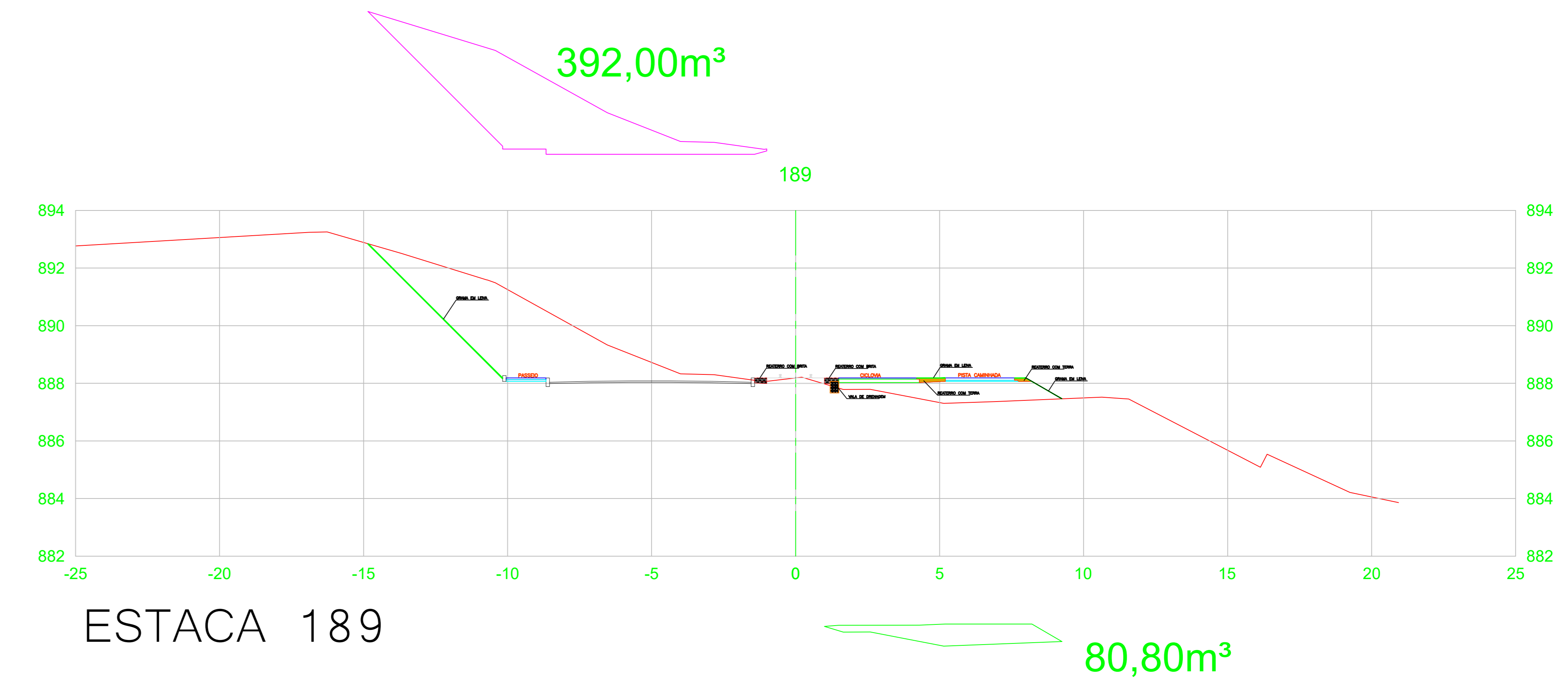
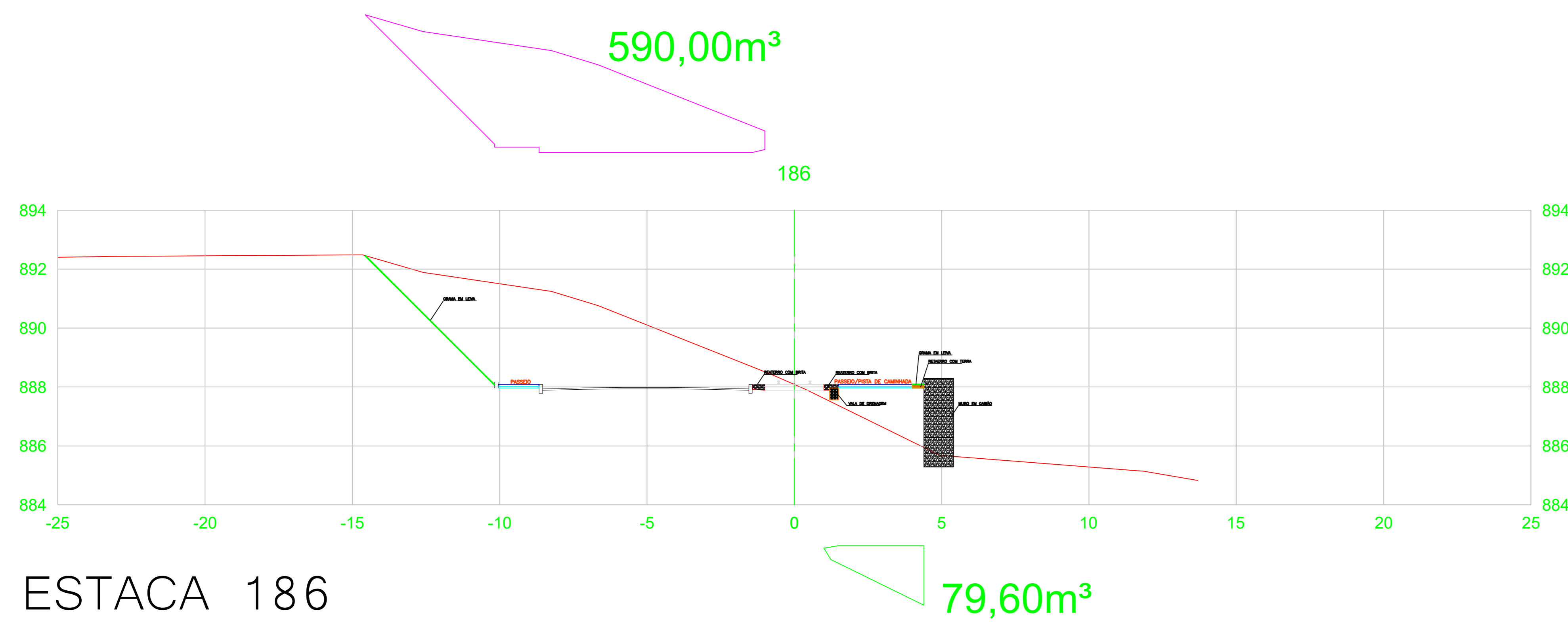

ESTACA 185

GEOMÉTRICO - PARQUE LINEAR DE CAÇADOR		FOLHA
	Referência	05/09
	PARQUE LINEAR DE CAÇADOR SEÇÃO 01 TRECHO ESTACA 177 - 203 TRECHO 05	Data
Revisões		12 março 2020
Responsável Técnico	Área INDICADA	
EMERSON SCHMIDT - CREA 45145-0	Escala 1/100	
	Desenho EMERSON	
	Arquivo	

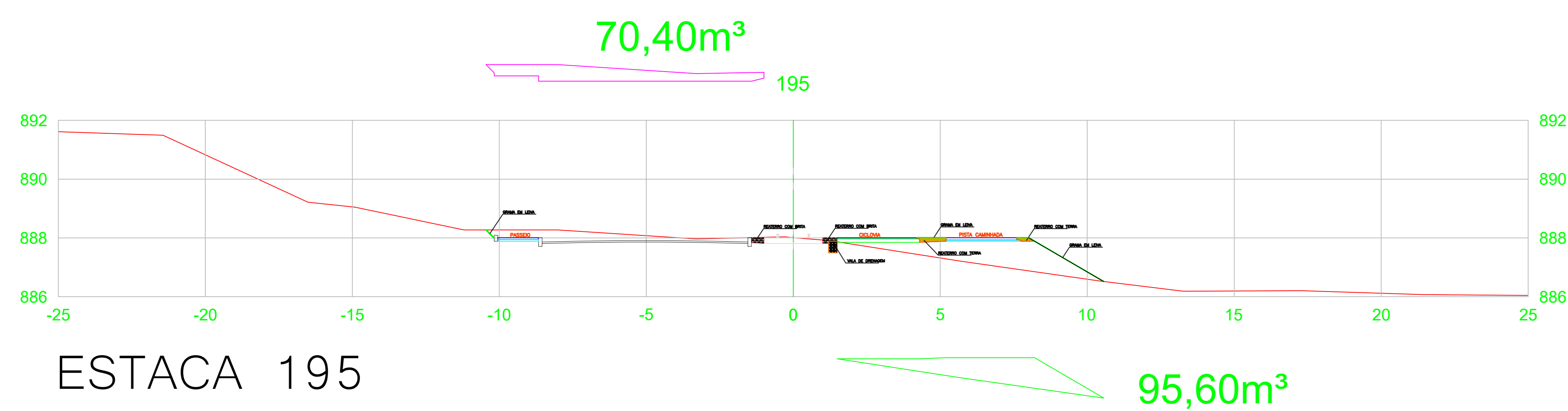
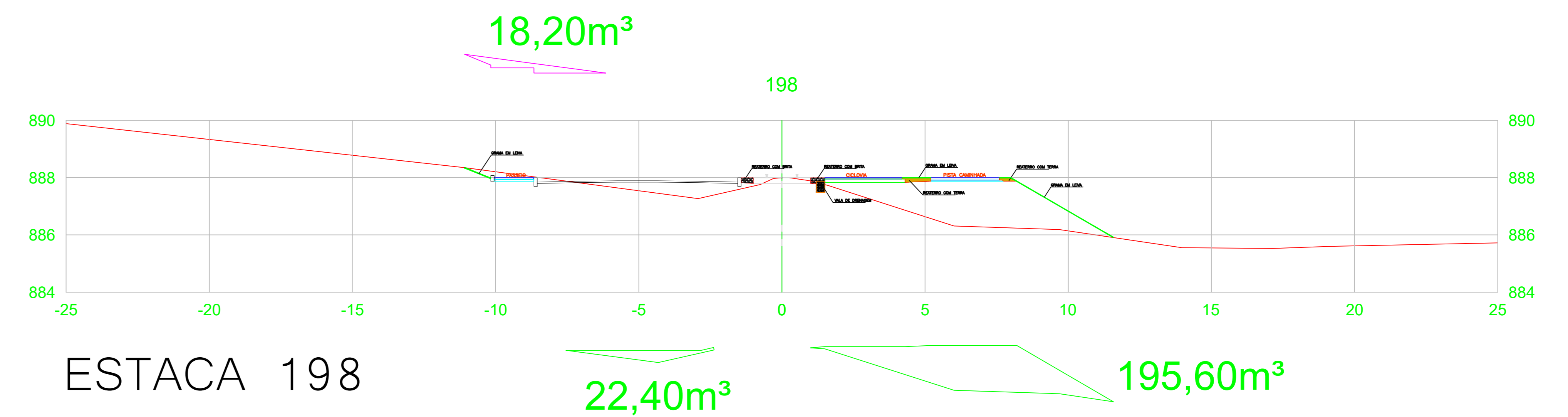
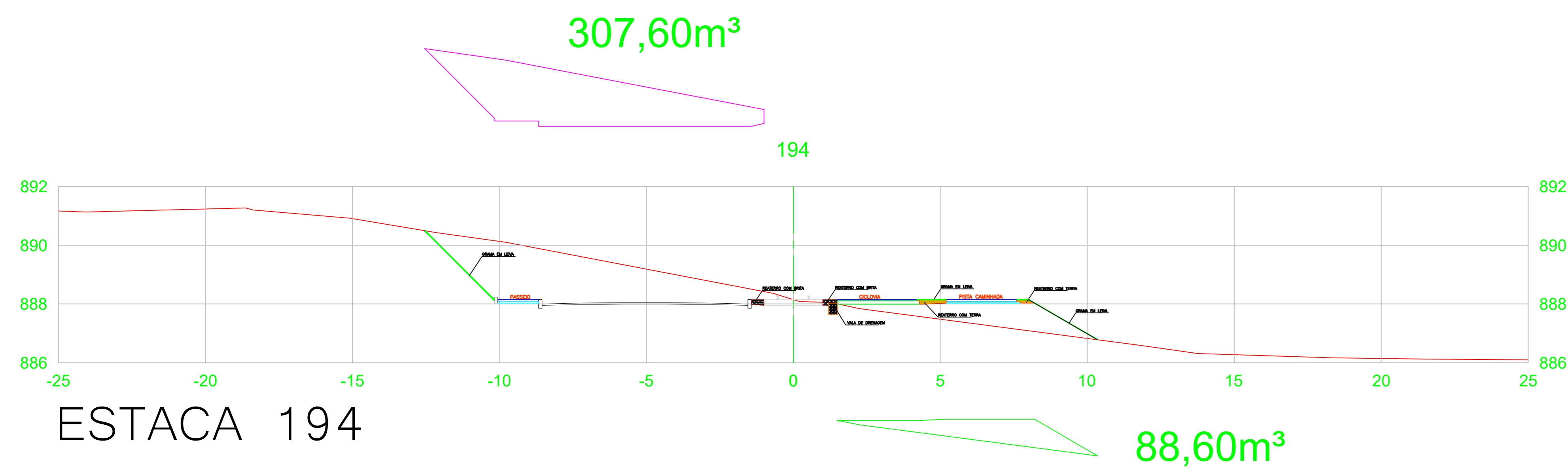
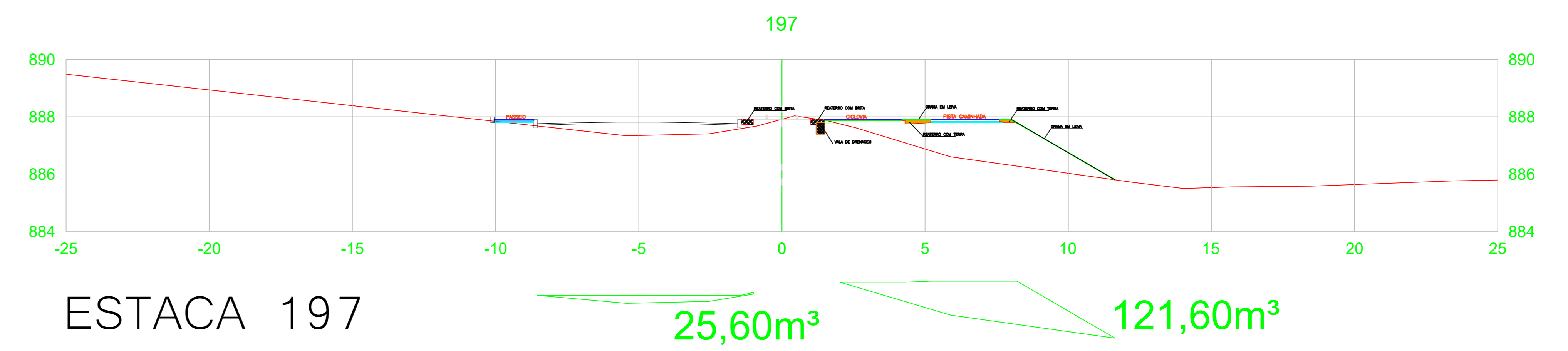
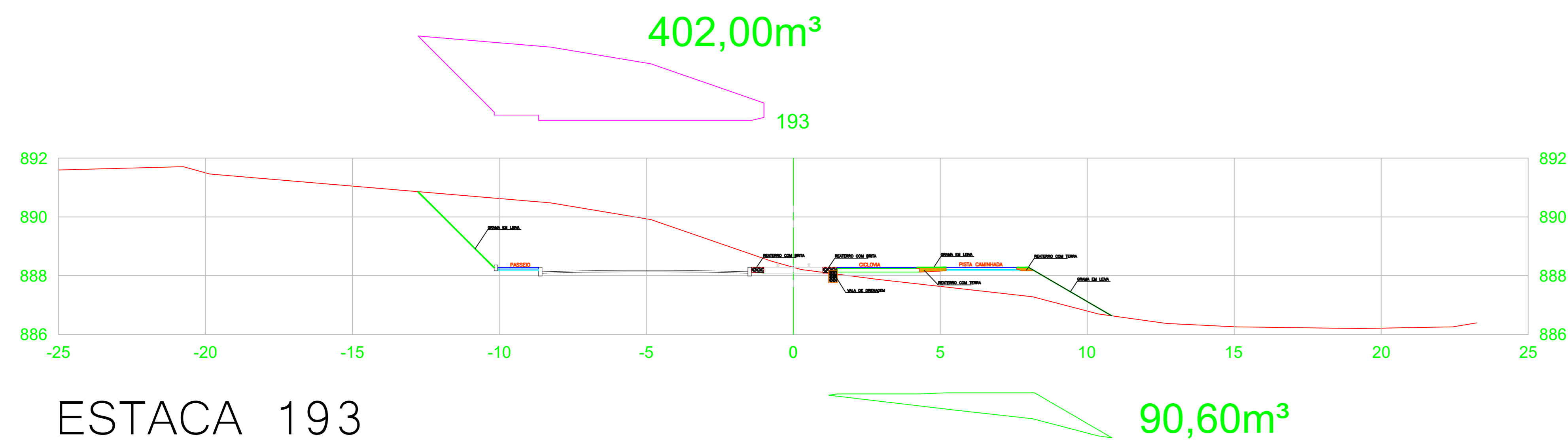
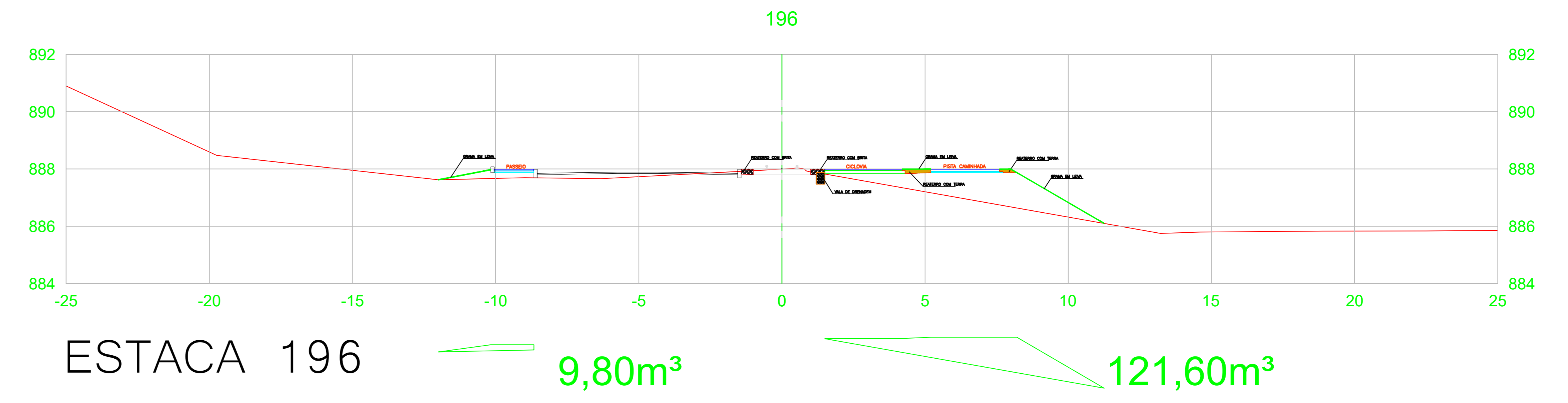
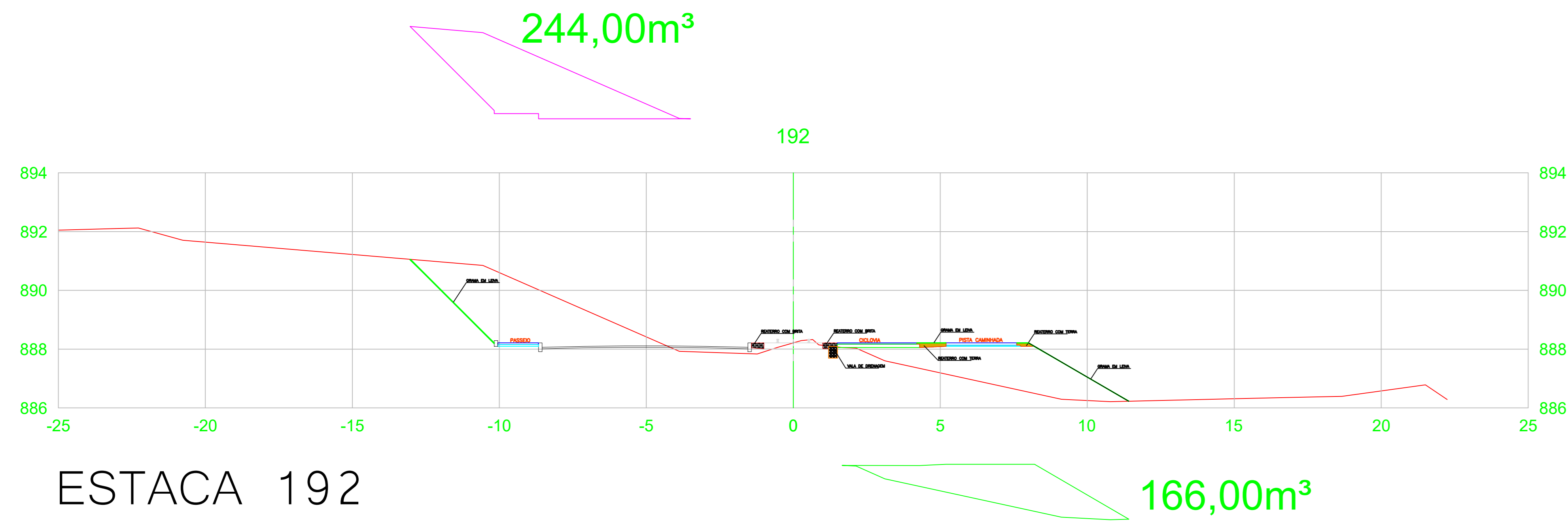

GEOMÉTRICO - PARQUE LINEAR DE CAÇADOR		FOLHA
<p>IPPUC INSTITUTO DE PESQUISA E PLANEJAMENTO URBANO DE CAÇADOR</p>	Referência	06/09
	PARQUE LINEAR DE CAÇADOR SEÇÃO 01 TRECHO ESTACA 177 - 203 TRECHO 05	Data
Respostável Técnico	Área	INDICADA
EMERSON SCHMIDT - CREA 45145-0	Escala	1/100
	Desenho	EMERSON
	Arquivo	D:\PPI\Parque Linear\PARQUE LINEAR PREC\TRECHO 05.dwg



GEOMÉTRICO - PARQUE LINEAR DE CAÇADOR		FOLHA
 IPPUC INSTITUTO DE PESQUISA E PLANEJAMENTO URBANO DE CAÇADOR	Referência: PARQUE LINEAR DE CAÇADOR SEÇÃO 01 TRECHO ESTACA 177 - 203 TRECHO 05	07/09 Data: 12 março 2020
	Responsável Técnico: EMERSON SCHMIDT - CREA 45145-0	Área INDICADA: Escala 1/100 Desenho EMERSON Arquivo: 01\PPH\PARQUE LINEAR PREC\TRECHO 05.dwg

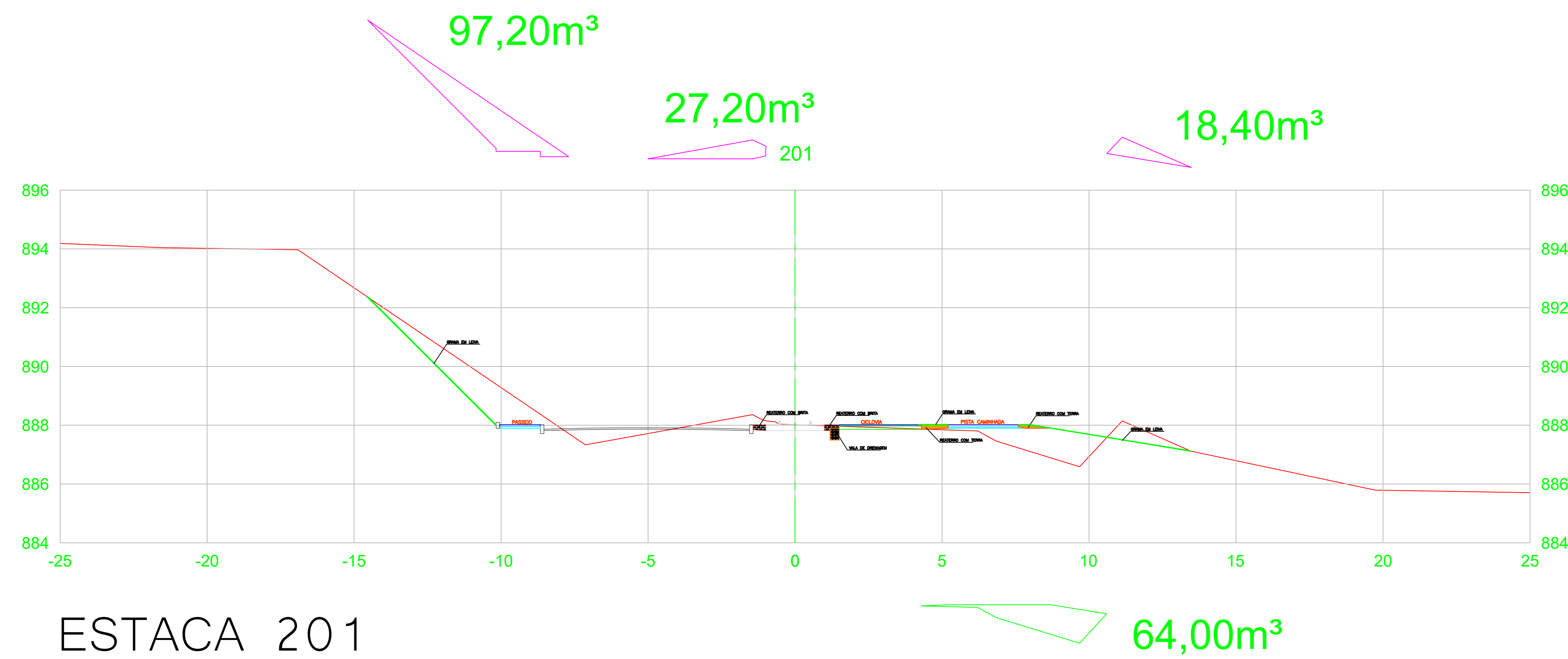
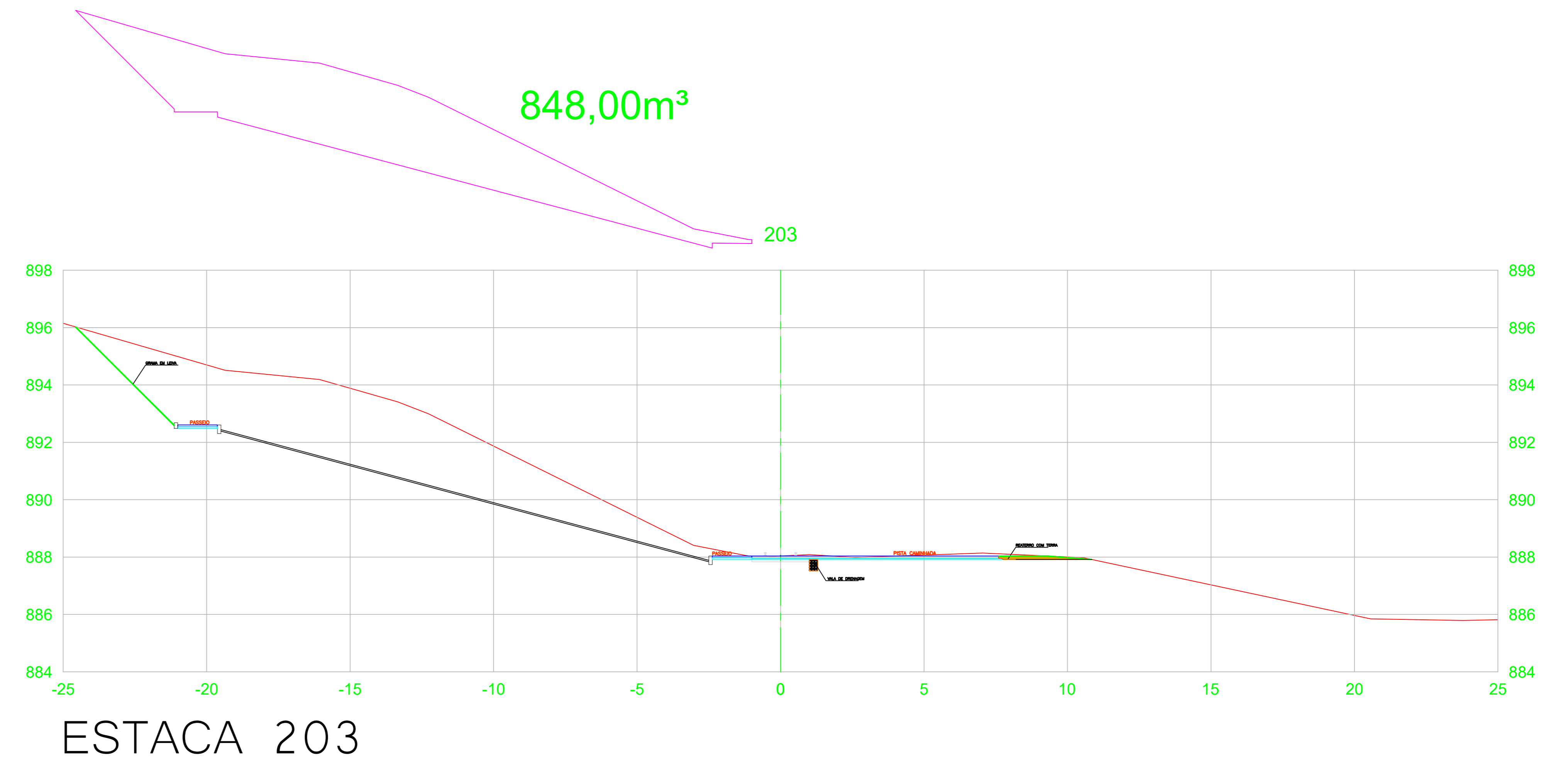
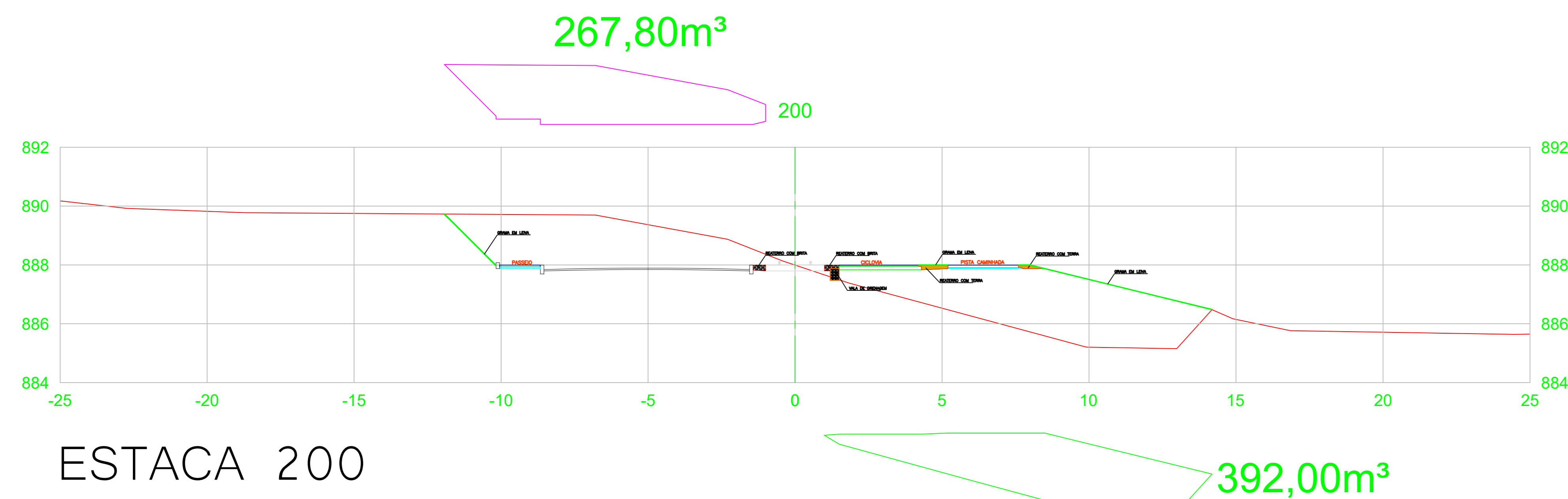
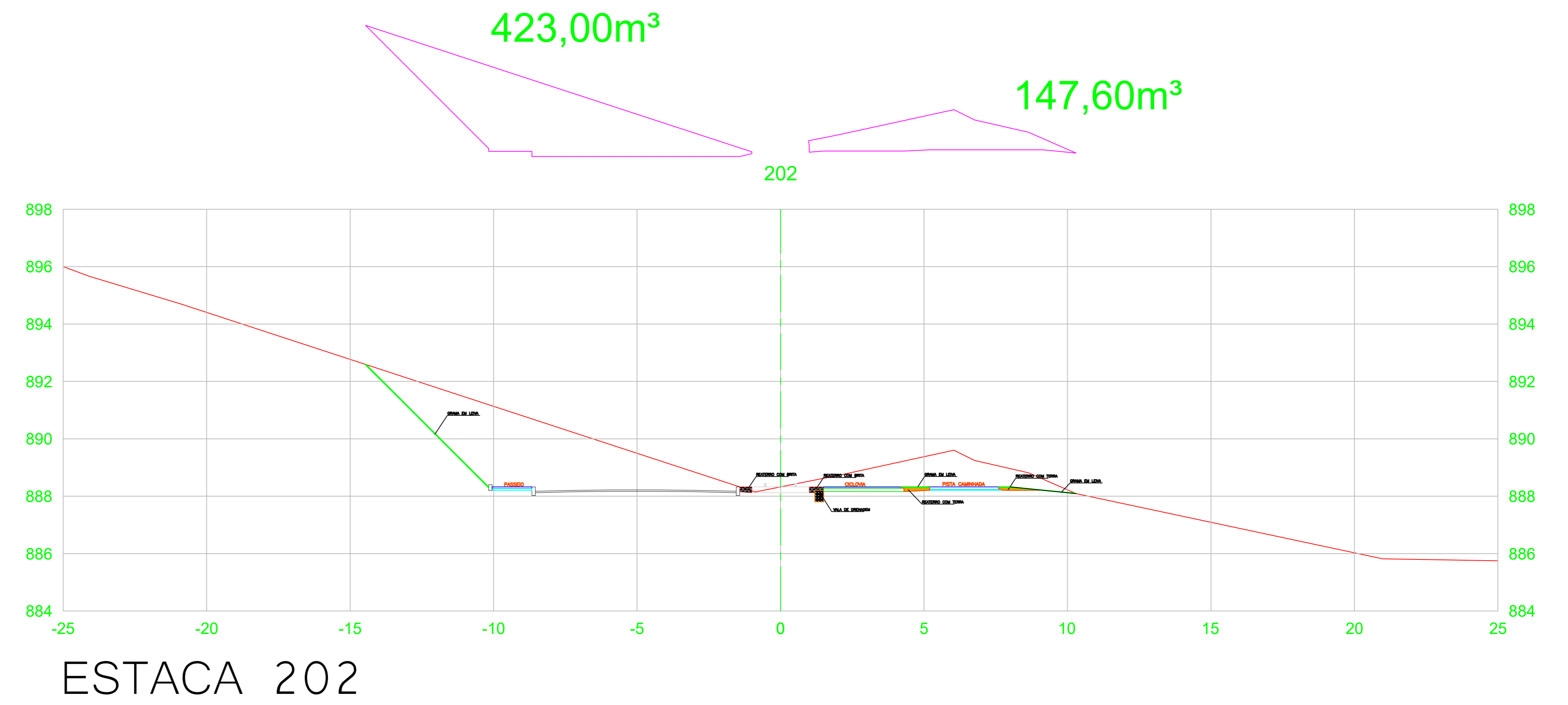
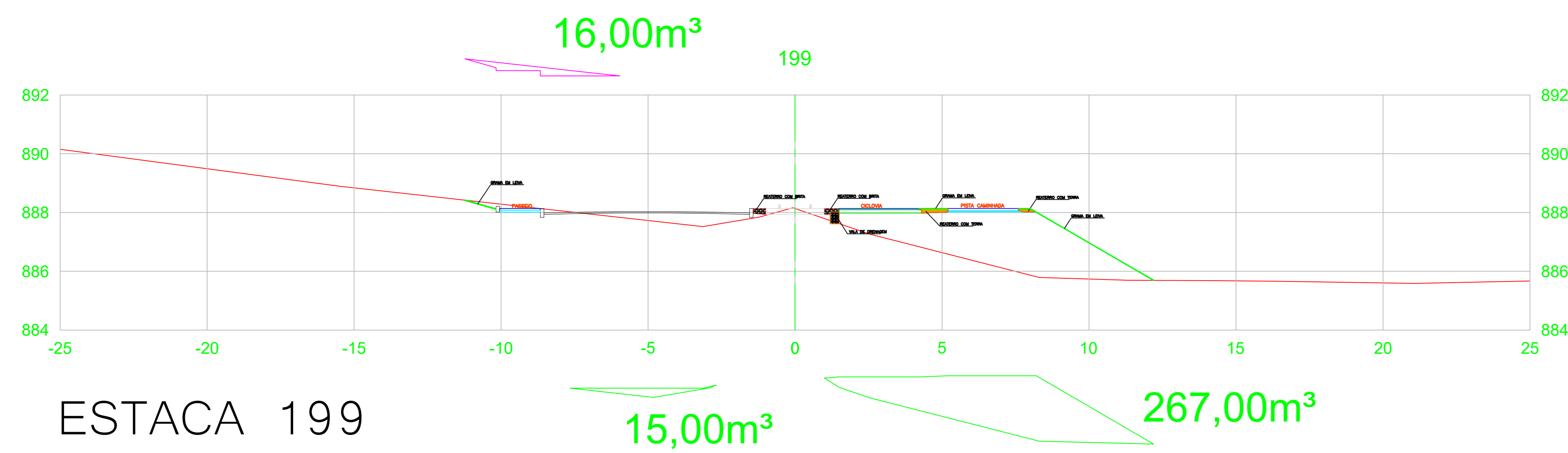

GEOMÉTRICO - PARQUE LINEAR DE CAÇADOR		FOLHA
 <p>IPPUC INSTITUTO DE PESQUISA E PLANEJAMENTO URBANO DE CAÇADOR</p>	Referência	08/09
	PARQUE LINEAR DE CAÇADOR SEÇÃO 01 TRECHO ESTACA 177 - 203 TRECHO 05	Data
Responsável Técnico	Área	INDICADA
EMERSON SCHMIDT - CREA 45145-0	Escala	1/100
	Desenho	EMERSON
	Arquivo	D:\PPUC\PARQUE LINEAR PRECATORIO DE ENG

ESTACA 186

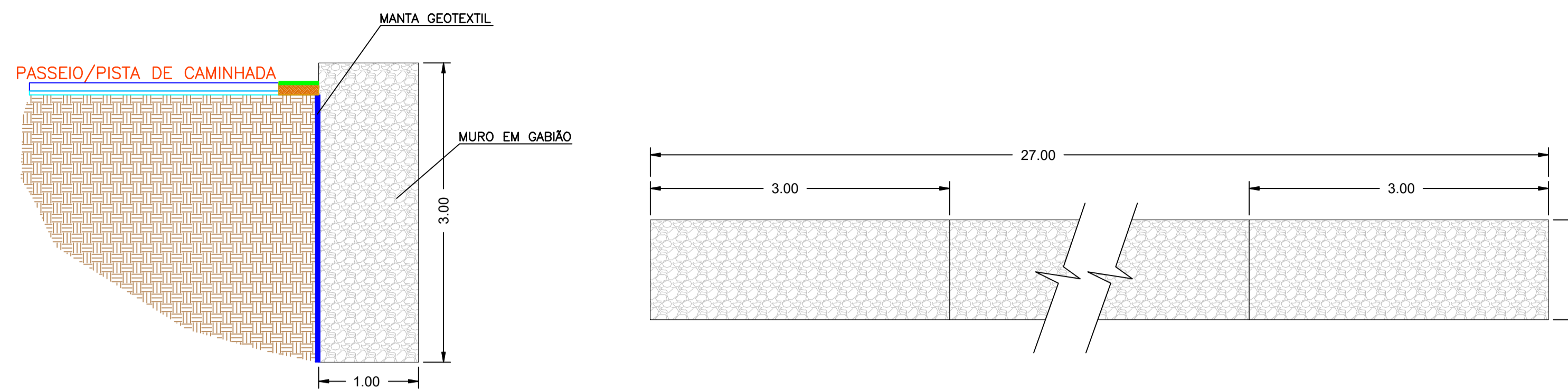

ESTACA 188

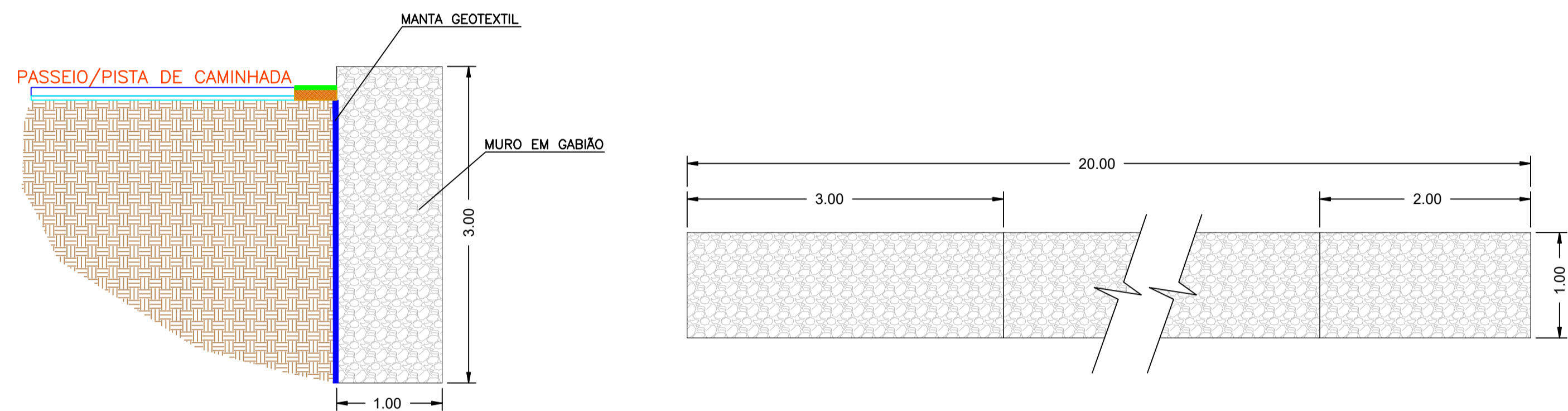

DETALHE DA BOCA DE LOBO

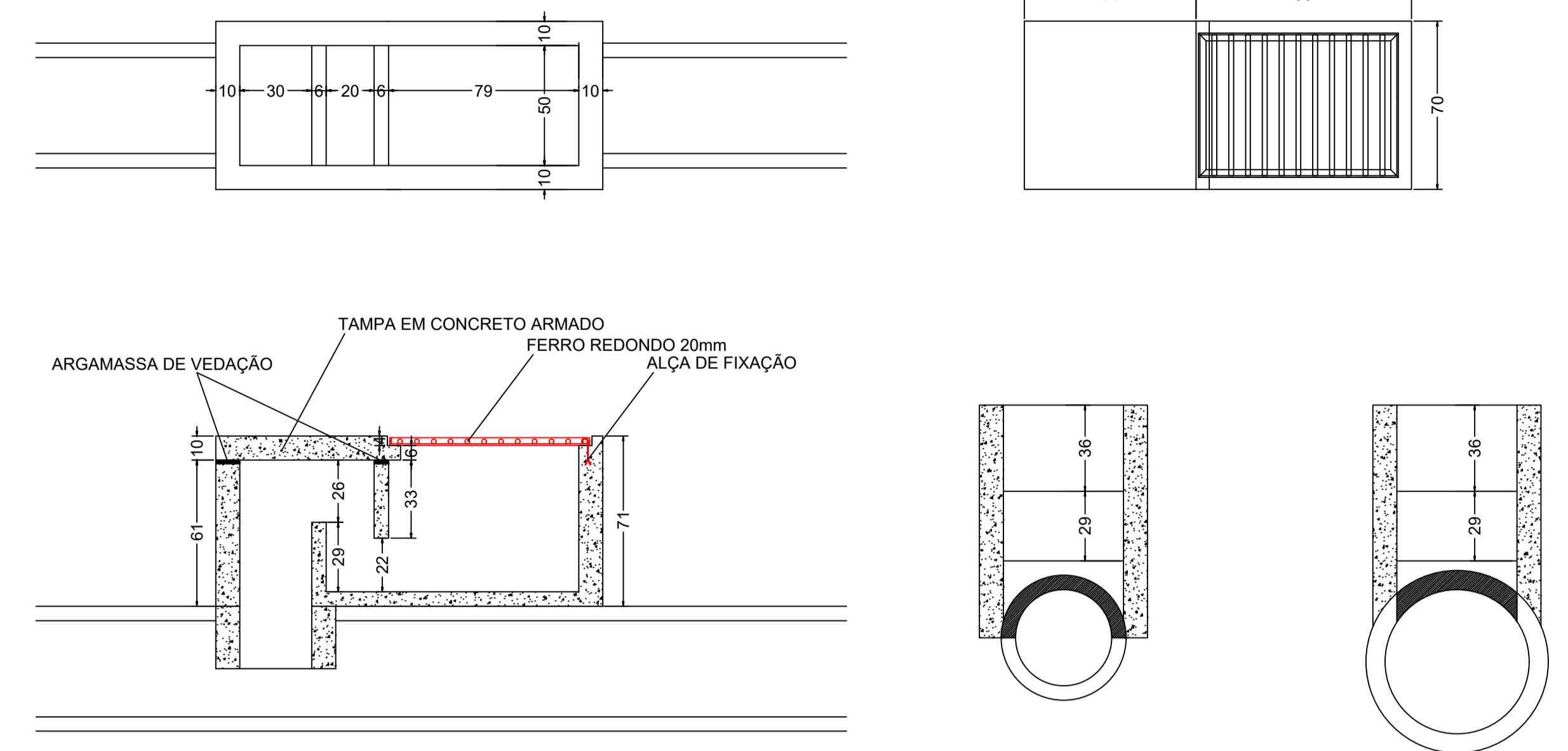

ESC. 1/20

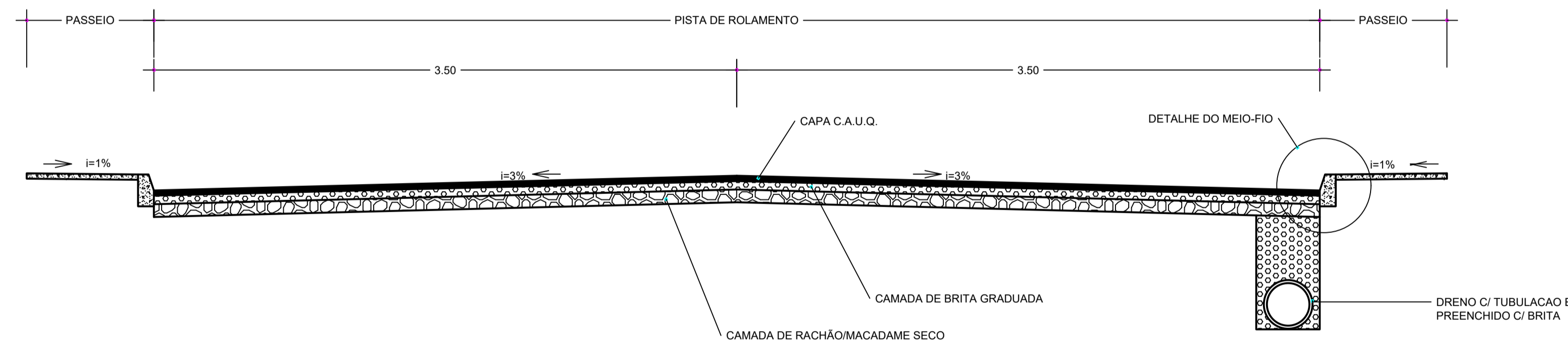
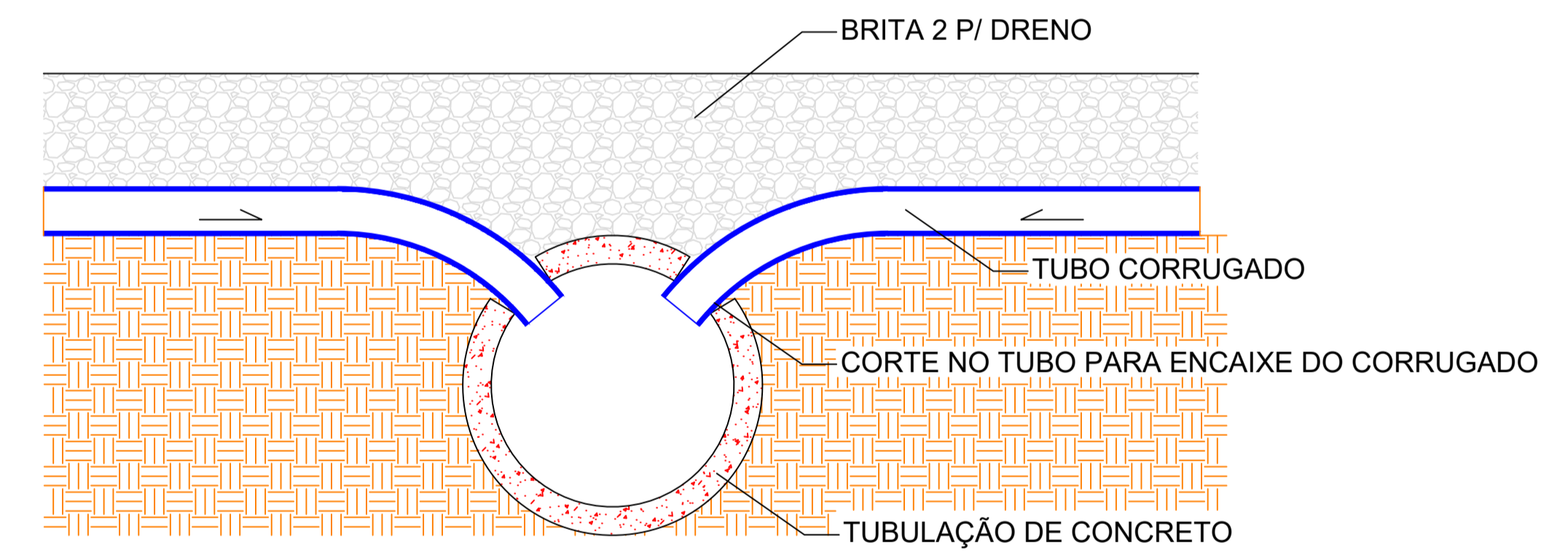

LIGAÇÃO DRENAGEM - TUBULAÇÃO



SEÇÃO TRANSVERSAL
SEM ESCALA

Projeto DRENAGEM - PARQUE LINEAR DE CAÇADOR		FOLHA
	Referência DETALHES MURO GABIÃO - BOCAS DE LOBO LIGAÇÃO DRENAGEM - SEÇÃO PAVIMENTO TRECHO ESTACA 177 - 203 TRECHO 05	09/09
	Revisões	Data 12 março 2020
Responsável Técnico	Área Indicada	
Eng. Civil Carine Marcon CREA SC 098.839-2	Escala 1/300	
	Desenho Carine	
	Arquivo D:\Prefeitura\PARQUE LINEAR PM\TRECHO 05.dwg	